

Invacare® Action® NG Family

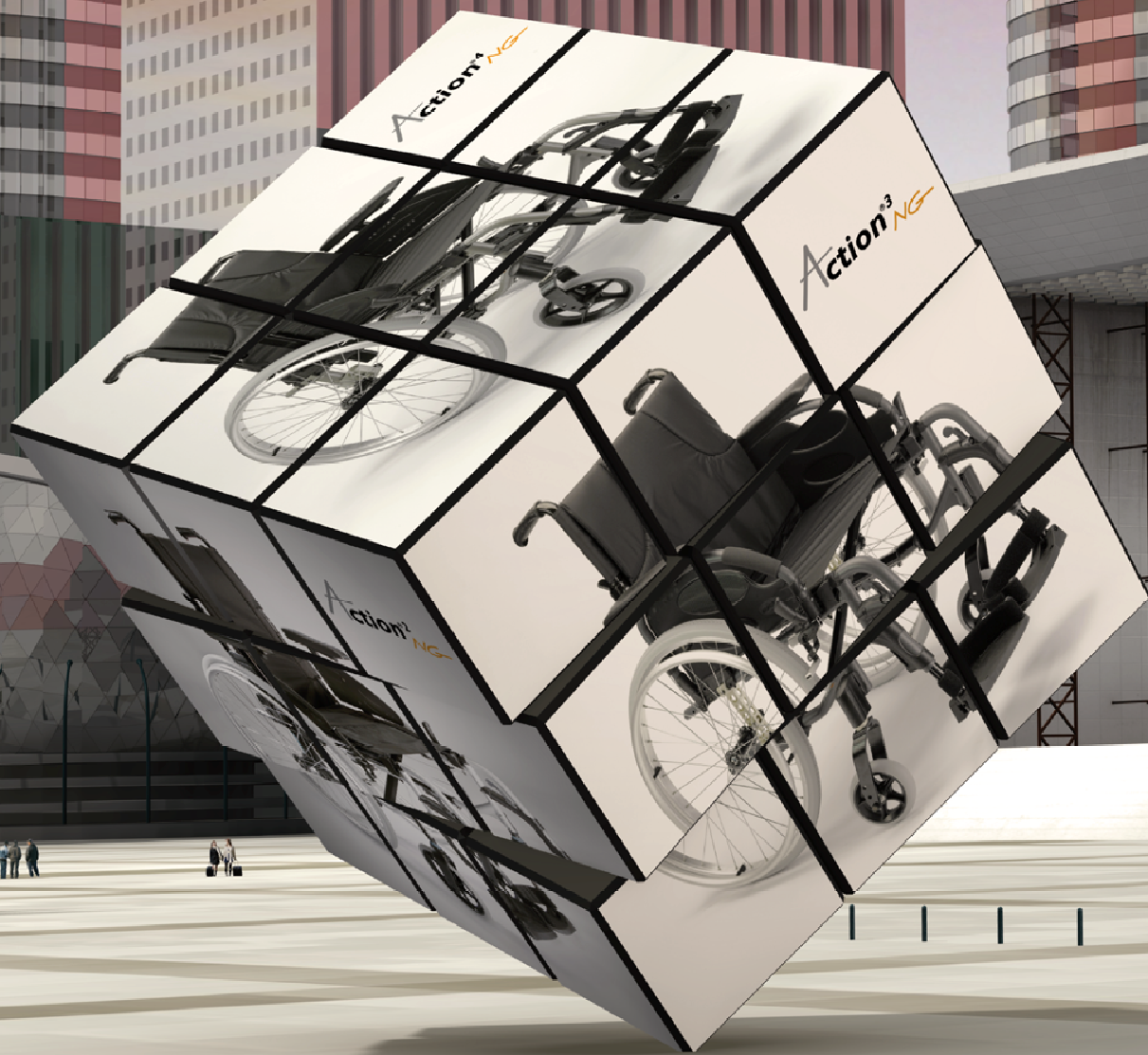





Seat height adjustments 2011

Yes, you can.®





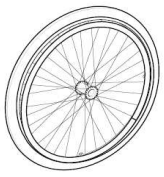

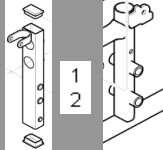
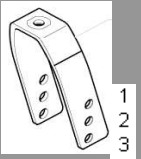

Optimize your business with an all-in-one solution.

**Invacare® Action 1 NG**

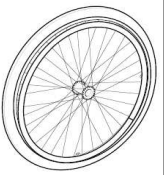
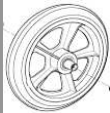
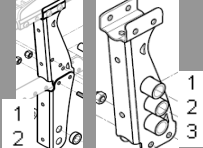
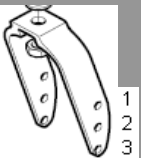

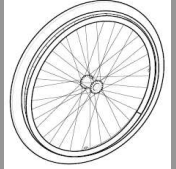

Seat height	Seat angle	Rear wheel size	Front wheel size	Rear wheel position	Front wheel position
				<i>Transit / Self propulsion</i> 	
500 mm	3°	24"	8"	2	3
	3°	12"	8"	2	3
450 mm	3°	24"	8"	1	1
	3°	12"	8"	1	1

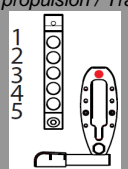
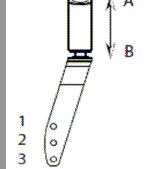
**Invacare® Action 2 NG**

Seat height	Seat angle	Rear wheel size	Front wheel size	Rear wheel position	Front wheel position
				<i>Transit / Self propulsion</i> 	
510 mm	3°	24"	8"	3	3
	3°	12"	8"	2	3
485 mm	3°	24"	8"	2	2
	3°	24"	6"	2	3
	3°	12"	8"	1	2
	3°	12"	6"	1	3
460 mm	3°	24"	6"	1	2



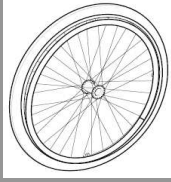

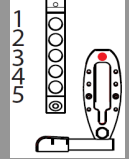
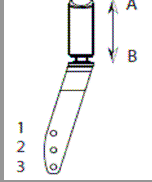
Seat height	Seat angle	Rear wheel size	Front wheel size	Rear wheel position <i>Self propulsion / Transit</i>	Front wheel position
					
510 mm	3°	24"	8"	5	B3
	3°	12"	8"	3	B3
	6°	24"	8"	4	B3
	6°	22"	8"	5	B3
	6°	12"	8"	2	B3
485 mm	0°	24"	8"	5	A3 / B2
	0°	24"	6"	5	B3
	0°	12"	8"	3	A3 / B2
	3°	24"	8"	4	A3 / B2
	3°	24"	6"	4	B3
	3°	22"	8"	5	A3 / B2
	3°	22"	6"	5	B3
	3°	12"	8"	2	A3 / B2
	6°	24"	8"	3	A3 / B2
	6°	24"	6"	3	B3
	6°	22"	8"	4	A3 / B2
	6°	22"	6"	4	B3
460 mm	0°	24"	8"	4	A2
	0°	24"	6"	4	A3 / B2
	0°	22"	8"	5	A2
	0°	22"	6"	5	A3 / B2
	0°	12"	8"	2	A2
	3°	24"	8"	3	A2
	3°	24"	6"	3	A3 / B2
	3°	22"	8"	4	A2
	3°	22"	6"	4	A3 / B2
	3°	12"	8"	1	A2
	6°	24"	8"	2	A2
	6°	24"	6"	2	A3 / B2
	6°	22"	8"	3	A2
	6°	22"	6"	3	A3 / B2
435 mm	0°	24"	6"	3	A2 / B1
	0°	22"	6"	4	A2 / B1
	3°	24"	6"	2	A2 / B1
	3°	22"	6"	3	A2 / B1
	6°	24"	6"	1	A2 / B1
	6°	22"	6"	2	A2 / B1

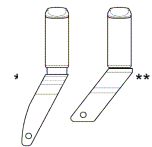

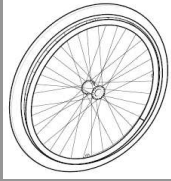

## Invacare® Action 3 NG

Seat height	Seat angle	Rear wheel size	Front wheel size	Rear wheel position	Front wheel position
				Self propulsion / Transit 	
410 mm	0°	24"	6"	2	A1
	0°	22"	6"	3	A1
	3°	24"	6"	1	A1
	3°	22"	6"	2	A1
	6°	22"	6"	1	A1
385 mm	0°	24"	5"	1	A1 *
	0°	22"	5"	2	A1 *
	0°	20"	5"	2	B1 **
	3°	22"	5"	1	A1 *
	3°	20"	5"	1	B1 **
360 mm	0°	20"	5"	1	A1 **

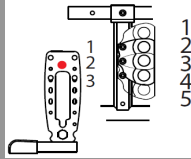
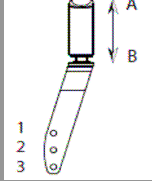



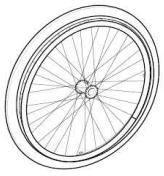

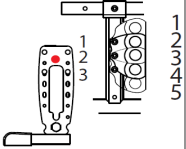
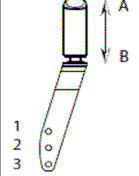
## Invacare® Action 4 NG

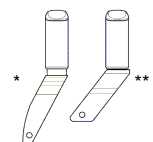
Seat height	Seat angle	Rear wheel size	Front wheel size	Rear wheel position	Front wheel position
				Transit / Self propulsion 	
510 mm	3°	24"	8"	5	B3
	3°	12"	8"	3	B3
	6°	24"	8"	4	B3
	6°	22"	8"	5	B3
	6°	12"	8"	2	B3
485 mm	0°	24"	8"	5	A3 / B2
	0°	24"	6"	5	B3
	0°	12"	8"	3	A3 / B2
	3°	24"	8"	4	A3 / B2
	3°	24"	6"	4	B3
	3°	22"	8"	5	A3 / B2
	3°	22"	6"	5	B3
	3°	12"	8"	1	A3 / B2

Seat height	Seat angle	Rear wheel size	Front wheel size	Rear wheel position	Front wheel position
				<i>Transit / Self propulsion</i> 	
485 mm	6°	24"	8"	3	A3 / B2
	6°	24"	6"	3	B3
	6°	22"	8"	4	A3 / B2
	6°	22"	6"	4	B3
	6°	12"	8"	2	A3 / B2
460 mm	0°	24"	8"	4	A2
	0°	24"	6"	4	A3 / B2
	0°	22"	8"	5	A2
	0°	22"	6"	5	A3 / B2
	0°	12"	8"	2	A2
	3°	24"	8"	3	A2
	3°	24"	6"	3	A3 / B2
	3°	22"	8"	4	A2
	3°	22"	6"	4	A3 / B2
	3°	12"	8"	1	A2
	6°	24"	8"	2	A2
	6°	24"	6"	2	A3 / B2
	6°	22"	8"	3	A2
435 mm	0°	24"	6"	3	A2 / B1
	0°	22"	6"	4	A2 / B1
	0°	12"	6"	1	A2 / B1
	3°	24"	6"	2	A2 / B1
	3°	22"	6"	3	A2 / B1
	6°	24"	6"	1	A2 / B1
	6°	22"	6"	2	A2 / B1
410 mm	0°	24"	6"	2	A1
	0°	22"	6"	3	A1
	3°	24"	6"	1	A1
	3°	22"	6"	2	A1
	6°	22"	6"	1	A1
385 mm	0°	24"	5"	1	A1 *
	0°	22"	5"	2	A1 *
	0°	20"	5"	2	B1 **
	3°	22"	5"	1	A1 *
	3°	20"	5"	1	B1 **
360 mm	0°	20"	5"	1	A1 **

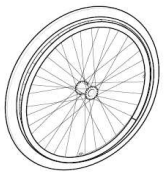

**Invacare® Action 3 Junior**

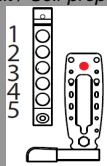
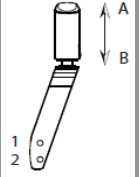
Seat height	Seat angle	Rear wheel size	Front wheel size	Rear wheel position <i>Transit / Self propulsion</i>	Front wheel position
					
460 mm	0°	22"	5"	5	B2
	0°	12"	5"	4	B2
	3°	22"	5"	4	B2
	3°	20"	5"	5	B2
	3°	12"	5"	5	B2
	6°	22"	5"	3	B2
	6°	20"	5"	4	B2
435 mm	0°	22"	5"	4	A2 / B1
	0°	20"	5"	5	A2 / B1
	0°	12"	5"	3	A2 / B1
	3°	22"	5"	3	A2 / B1
	3°	20"	5"	4	A2 / B1
	3°	12"	5"	4	A2 / B1
	6°	22"	5"	2	A2 / B1
	6°	20"	5"	3	A2 / B1
	6°	12"	5"	5	A2 / B1
410 mm	0°	22"	5"	3	A1
	0°	20"	5"	4	A1
	0°	12"	5"	2	A1
	3°	22"	5"	2	A1
	3°	20"	5"	3	A1
	3°	12"	5"	3	A1
	6°	22"	5"	1	A1
	6°	20"	5"	2	A1
	6°	12"	5"	4	A1